ACCESSORY POWER™



**SMART
mini**

INSTRUCTION MANUAL

FREE PRODUCT REGISTRATION

Protect your investment and take advantage of this free product warranty.

YOU MUST REGISTER WITHIN 30 DAYS

of purchase to receive full warranty coverage and access to special offers.

www.AccessoryPower.com/warranty

Thank you for purchasing the **GOgroove™ SMARTmini™** Bluetooth® FM transmitter. Utilizing the latest technology in both the FM transmitting and Bluetooth industry, this device allows you to make hands-free calls and listen to music over your car speakers. It's easy to setup with any smartphone, tablet, MP3 player, and other Bluetooth enabled devices. It even has a USB charging port to keep your device powered up. **DO IT ALL WITH THE SMARTmini!**

What's in the box?

- a- SMARTmini Bluetooth FM transmitter
- b- 3.5mm audio cable
- c- MicroUSB charging cable
- d- MiniUSB charging cable



Product Diagram

- 1- LED display
- 2- Control knob
- 3- ▶|| Play/Pause
- 4- ◀◀ Previous song
- 5- ▶▶ Next song
- 6- ☎ Call button & blue indicator light
- 7- ☎ End call & red indicator light
- 8- DC barrel
- 9- USB power port
- 10- 3.5mm line-in port
- 11- 3.5mm line-out port
- 12- Microphone

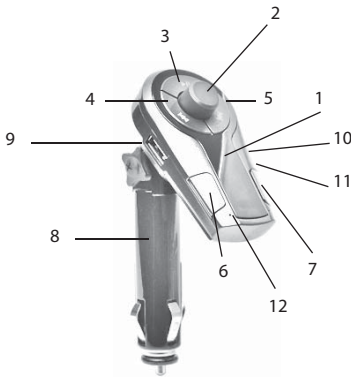



OPERATING INSTRUCTIONS:

Installation:

Simply insert the DC barrel of the **SMARTmini** into your vehicle's DC (cigarette lighter) outlet.

Pairing your mobile Bluetooth device to the SMARTmini:

Pairing instructions may differ between each mobile phone. Please refer to your mobile phone user's manual for further information.

- 1- Make sure that your mobile device is within at least 1 meter of the receiver when trying to pair.
- 2- Enter PAIRING MODE on the **SMARTmini** by holding down the (6) *Call button*.
- 3- Once you see the (6) *Call* and (7) *End call* buttons flashing, access the Bluetooth settings in your mobile device and select SEARCH. Your mobile device will begin to search for a Bluetooth signal.
- 4- You will see the name "**GG-SMARTMINI-BT**" appear in the device list. Select it to pair, and if a password or PIN is needed enter the numbers "0000". ***You may have to then select "**GG-SMARTMINI-BT**" and press "CONNECT".
- 5- After a successful connection has been made, the (7) *Red*  *end call* button and the (6) *Blue*  *call button* will illuminate. Your mobile device will indicate a "CONNECTED" status.





more >>>

Playing music:

- 1- Make sure that your mobile device is connected with a Bluetooth A2DP (audio/music) connection.
- 2- **Using auto-seek function:** Quickly find a free FM station by pressing down the (2) *Control knob* for about 3 seconds. You will see the displayed FM frequency change. Please match your car radio FM station to the station shown on the (1) *LED display*. You can also manually tune the station by rotating the (2) *Control knob*. Frequency adjusts from 88.1 to 107.9 MHz.
- 3- Simply begin playing music on your mobile device and you should hear the music play through your car stereo system. If the music is low, increase the volume on the **SMARTmini**, rather than the car radio. Please push the (2) *Control knob* once for volume adjustment. When you see a numeric value between 1 -30, you can then use the (2) *Control knob* to adjust volume up and down.
- 4- Use the (2) *Control knob* and buttons on the **SMARTmini** to toggle simple play functions such as volume adjustment, (3) *Play/Pause* ►||, (4) *Previous song* ◀◀, and (5) *Next song* ▶▶ buttons. Ability to use these play settings varies between each mobile device.
- 5- If you would like to connect a device which does not have Bluetooth capability, you may use the (10) *3.5mm line-In port*. Just use the included (b) *3.5mm audio cable*. Connect one end to the headphone jack of your music playing device, and the other end into the (10) *3.5mm line-In port*. Play controls on the **SMARTmini** will not function via the (10) *3.5mm line-in port*.

Hands-Free Calls:





HANDS FREE FUNCTIONS reference guide

Function	Phone Status	Directions
Answer call	Ringing	Press the  button
End call	Conversation mode	Press the  button
Reject call	Ringing	Hold the  button for about 2 seconds
Cancel call	Calling	Press the  button
Redial last call	Standby mode	Hold the  button for about 3 seconds
Adjust volume	ANY	Press the control knob, and then rotate the knob to adjust volume from 1(min) to 30(max)

Using 3.5mm Line-Out port in a car equipped with AUX input:

Connecting **SMARTmini** with the AUX input in your vehicle allows you to use the **SMARTmini** as a Bluetooth car receiver. This will allow you to wirelessly connect Bluetooth devices to your car speaker system, but rather than transmitting sound through an FM frequency, you are able to have a direct audio connection from the **SMARTmini** and your car speakers. This offers excellent sound quality with the convenience of wireless connectivity and control of your mobile phone or audio device.

What the indicator lights mean:

Light sequence	What it means
Red and blue indicator lights flash alternately 	SMARTmini is in PAIRING MODE
The red indicator light  is on	A successful HFP (Hands-Free) connection has been made
The blue indicator light  is on	A successful A2DP (audio/music) connection has been made
The indicator lights  are illuminated	Power is ON
The indicator lights  are flashing	Volume adjustment mode is active

Using the SMARTmini USB power port:

- 1- Make sure that the **SMARTmini** has been properly connected and the power is turned ON.
- 2- Connect one of the included cables: (c) *MicroUSB*, (d) *MiniUSB* or one of your own to the (9) *USB power port*.
- 3- Connect the other end of the USB cable to your mobile device. You will see a charging symbol on your mobile device to indicate the power is flowing.

Optimizing Sound and Performance:

There are variables that will affect the sound quality that you hear through your car stereo.

- 1) Volume setting on **SMARTmini** - Adjust the volume on **SMARTmini** to level 25-30. You can always adjust your car stereo master volume down if it gets too loud.
- 2) Adjust the TREBLE, BASS and MID on your car stereo to the desired level.
- 3) Use your device (smartphone or MP3 player) EQ settings to maximize sound output. Finally, make sure that your device's volume level is turned up to 90% or higher.
- 4) Removing your car's antenna will improve FM sound performance.

It's usually best to maximize the audio output from the **SMARTmini** and your device. Use your car stereo master volume to regulate the sound coming out of your speakers.

Trouble Shooting Guide:

1. Why is the red indicator light on?

SMARTmini is connected to a Bluetooth HFP (hands-free) device. You can make hands-free calls. Some phones only support an HFP connection.



2. Why is blue indicator light on?

SMARTmini is connected to a Bluetooth A2DP (audio/music) device. You can listen to music.

3. How come the audio is not clear through the car speakers?

- Please make sure the frequency of **SMARTmini** is the same as the frequency as your car FM stereo.
- Use the AUTO-SEEK function on the **SMARTmini** to find the clearest FM station.
- Removing your car's antenna will improve FM sound performance.

4. Why can't I get the SMARTmini to pair with my mobile device?

- Please make sure **SMARTmini** is in PAIRING MODE and that both BLUE  and RED  lights are flashing.
- Please unplug the **SMARTmini** and start from the beginning of "Pairing your mobile Bluetooth device to the SMARTmini" instructions earlier in this manual.

5. Why can't I play music using my mobile phone?

- Please make sure that your Bluetooth mobile phone supports A2DP (audio/music) connection, and that it has been paired properly.
- Please make sure that the volume on your car stereo and the **SMARTmini** are loud enough.
- Check your mobile phone volume.

6. When I play music I can't use pause, play, previous song, and next song buttons.

- Some of these functions need the Bluetooth device paired with **SMARTmini** to support AVRCP (Audio/Video Remote Control Profile). Please make sure your mobile phone or Bluetooth transmitter supports AVRCP.
- When using the (10) 3.5mm line-in port for audio, these controls do not have a function.

Care and maintenance:

- Do not expose the unit to dust, water, or extreme temperatures
- Do not attempt to disassemble the product.
- If the product is giving you problems, please contact the manufacturer or retailer.

Product Specifications:

Bluetooth version: Bluetooth V2.1

Bluetooth profiles: HSP, HFP, A2DP and AVRCP

Frequency response: 2.4GHz-2.4835GHz

FM frequency; 88.1-107.9MHz

Bluetooth range: 10M

FM range: 5M

Input: DC 12V 400mA

USB output: DC 5.0V 600mA

Weight: 2.6 ounces (74 gm)

Learn more about this and other
quality Accessory Power products



www.AccessoryPower.com



[Facebook.com/AccessoryPower](https://www.facebook.com/AccessoryPower)



[Twitter.com/AccessoryPower](https://twitter.com/AccessoryPower)

**For more on this product
+ tips and tricks please visit
AccessoryPower.com/videos**



ACCESSORY POWER
WESTLIFE VILLAGE, CALIFORNIA

WWW.ACCESSORYPOWER.COM
MADE IN CHINA

©2011 ACCESSORY POWER
All trademarks and brand names are the property of their owners



Please Always Recycle